



TL40/16





Codice testa
Head code

Codice mandrino
Spindle code

 N° prese di moto
Nr. spindle drives **08**

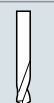
 Rapporto
Ratio **1-1**

 Capacità di foratura
Drilling capacity
acciaio R=500 N/mm²
ghisa: GG25 **16**
18

 Maschiatura
Tapping **M14**

 Attacco utensile
Type of spindle
D **DIN 55058 Ø25**

 Peso gruppo testa
Head weight **Kg 26**

 Peso gruppo mandrino
Spindle-set weight **Kg 2,5**

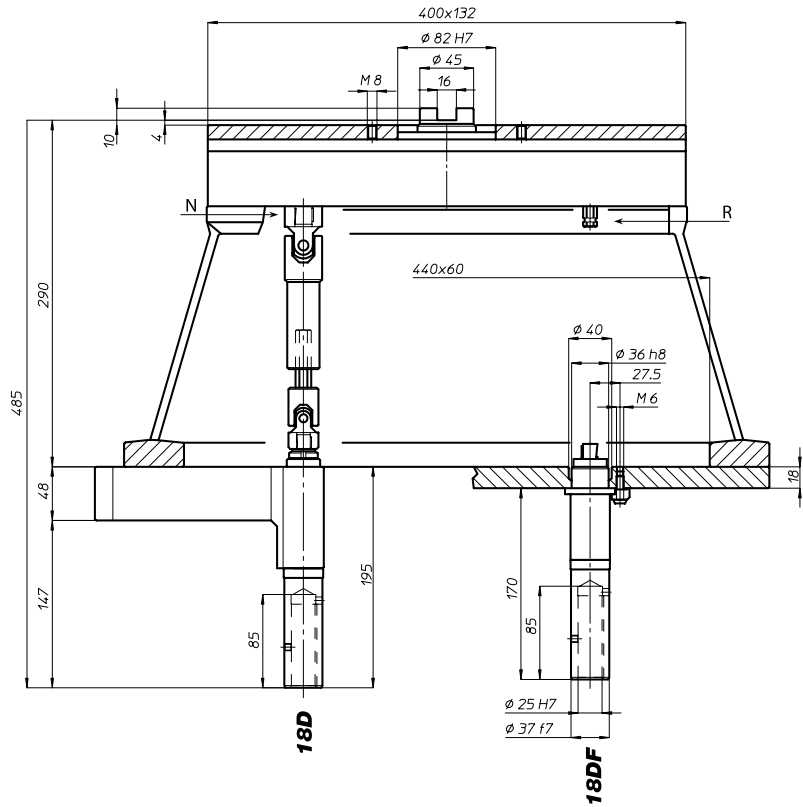
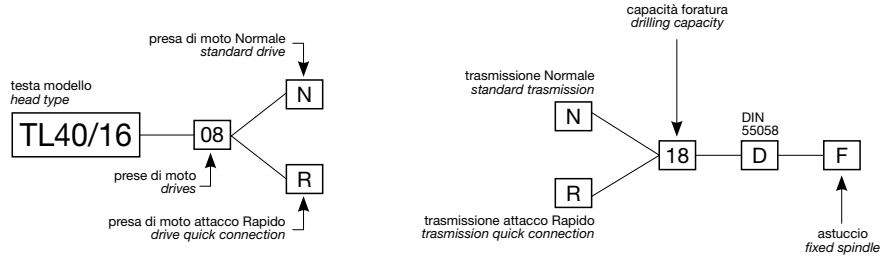

area di lavoro
working area

